



# allPIXA *neo*

**LINE SCAN CAMERA SERIES**

**4k / 6k / MONO / RGB / NIR**

**FAST  
VERSATILE  
ECONOMICAL**





# allPIXA neo 4k / 6k

Line Scan Camera with 10 GigE / CoaXPress Interface

Fast. Versatile. Economical.

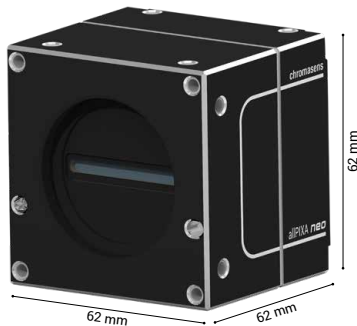

The allPIXA neo is a fast and versatile line scan camera coming in different versions with 4k and 6k resolution, pixel sizes of 7  $\mu\text{m}$  and 5  $\mu\text{m}$  and two interfaces: The 10 GigE interface enables easy and economical integration whereas the CoaXPress interface provides highest speeds up to 105 kHz in color and 300 kHz in mono. The camera captures up to 4 lines simultaneously for high quality color images and an additional mono or a NIR image. With its extensive features and trigger options, the allPIXA neo is the best choice for a wide range of line scan applications where high speed and best image quality are essential.

## CAMERA OVERVIEW:

- ▶ CMOS multi-line sensor with 4096 or 6144 pixels
- ▶ Two different pixel sizes: 7  $\mu\text{m}$  or 5  $\mu\text{m}$
- ▶ 10 GigE (10GBase-T) or 2 x CoaXPress (CXP-12) interface
- ▶ High speed: up to 105 kHz in color and 300 kHz in mono
- ▶ Supports PoE and PoCXP (Power over GigE or CoaXPress)
- ▶ Camera models for Mono, RGB, and RGB+NIR available
- ▶ Configurable voltage range for input signals
- ▶ Various optical mounts: M42, F-Mount and TFL-Mount





## FEATURES:

- ▶ Frame and line trigger options including variable encoder input
- ▶ DSNU and PRNU correction
- ▶ Continuous and automatic white balancing
- ▶ Precise multi-camera synchronization
- ▶ Multi-Flash function for multiple image acquisition in one pass
- ▶ Color correction matrix for optimized color image representation
- ▶ SDK and graphical tool for Windows and Linux
- ▶ Fully GenICam and GigE Vision compliant

## TYPICAL APPLICATIONS:

- High speed web inspection
- Sorting processes
- Logistics
- Food inspection
- High quality surface
- Wood inspection
- Electronics
- Battery Inspection
- Print & Packaging
- Pharma
- General machine vision

## SPECIFICATIONS:

	allPIXA neo 4k		allPIXA neo 6k	
Interface				
Sensor	CMOS	CMOS	CMOS	CMOS
Number of pixels	4096	4096	6144	6144
Active pixel size	7 μm x 7 μm	7 μm x 7 μm	5 μm x 5 μm	5 μm x 5 μm
Interface connector	RJ45 (10GBASE-T)	2x CXP-12	RJ45 (10GBASE-T)	2x CXP-12
Max. line rate, single line	270 kHz	300 kHz	180 kHz	240 kHz
Max. line rate, Tri-linear	90 kHz	105 kHz	60 kHz	80 kHz
Max. line rate, quad-linear	70 kHz	80 kHz	45 kHz	60 kHz
Power over ethernet/CXP	PoE	PoCXP	PoE	PoCXP
Data format	8/10/12 Bit			
Power supply	12-24V DC ± 10%			
Trigger mode	Free run, external trigger, line trigger, frame trigger or encoder			
Operating temperature	0° to 60° housing temperature			
Dimensions	62 mm x 62 mm x 62 mm			
Lens mount	M42 x 1/F-mount/TFL adapters			
Weight	350 g			
Certifications	CE; RoHS			

Product Code	Product Description	Sensor Type	Mono	RGB	NIR-block filter	Readout Mode		
						Single Line	Tri-linear	Quad-linear
CP000660-04K-77-M1-A1	allPIXA neo 4k 10GigE Mono	Mono	✓			✓		
CP000660-04K-44-M1-A1	allPIXA neo 4k CXP Mono (on request)	Mono	✓			✓		
CP000660-04K-77-C1-A1	allPIXA neo 4k 10GigE Color	Color + Mono	✓	✓		✓	✓	✓
CP000660-04K-44-C1-A1	allPIXA neo 4k CXP Color	Color + Mono	✓	✓		✓	✓	✓

CP000660-06K-77-M1-A1	allPIXA neo 6k 10GigE Mono	Mono	✓			✓		
CP000660-06K-44-M1-A1	allPIXA neo 6k CXP Mono (on request)	Mono	✓			✓		
CP000660-06K-77-C1-A1	allPIXA neo 6k 10GigE Color	Color + Mono	✓	✓		✓	✓	✓
CP000660-06K-44-C1-A1	allPIXA neo 6k CXP Color	Color + Mono	✓	✓		✓	✓	✓
CP000660-06K-77-C2-A1	allPIXA neo 6k 10GigE Color-NIR	Color + NIR		✓	✓	✓	✓	✓
CP000660-06K-44-C2-A1	allPIXA neo 6k CXP Color-NIR	Color + NIR		✓	✓	✓	✓	✓

Spectral Sensitivity for allPIXA neo mono and color

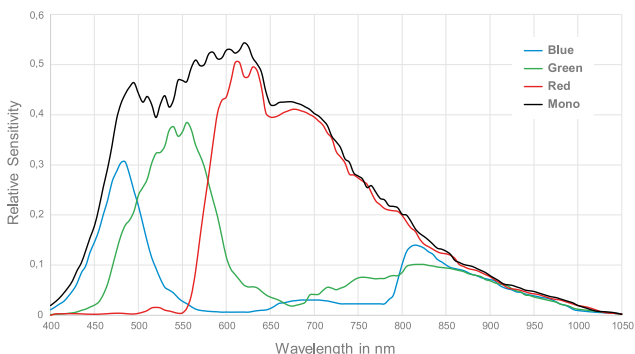

Spectral Sensitivity for allPIXA neo with NIR option

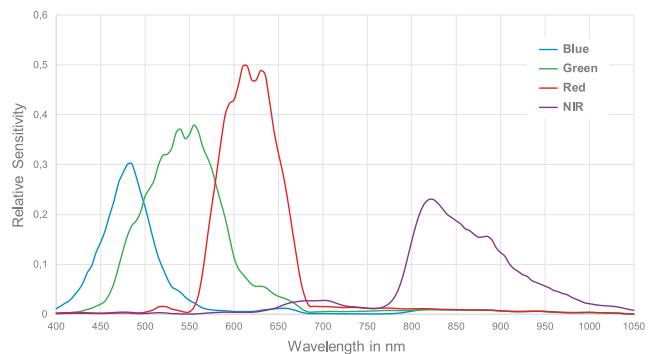

## SENSOR LINES

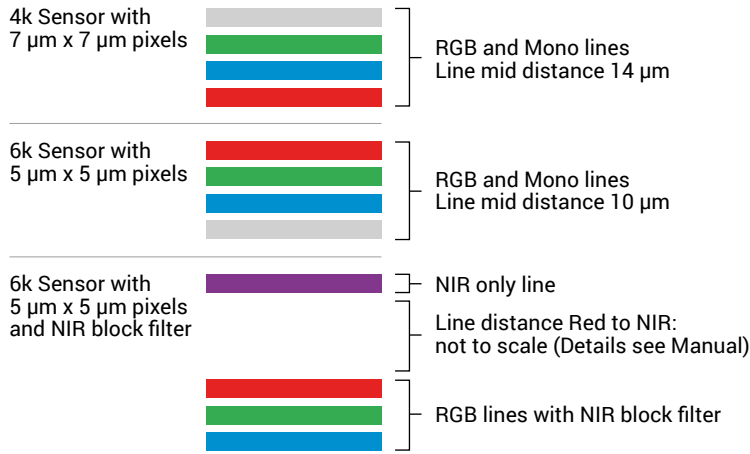

### allPIXA neo 4k / 6k 10 GigE

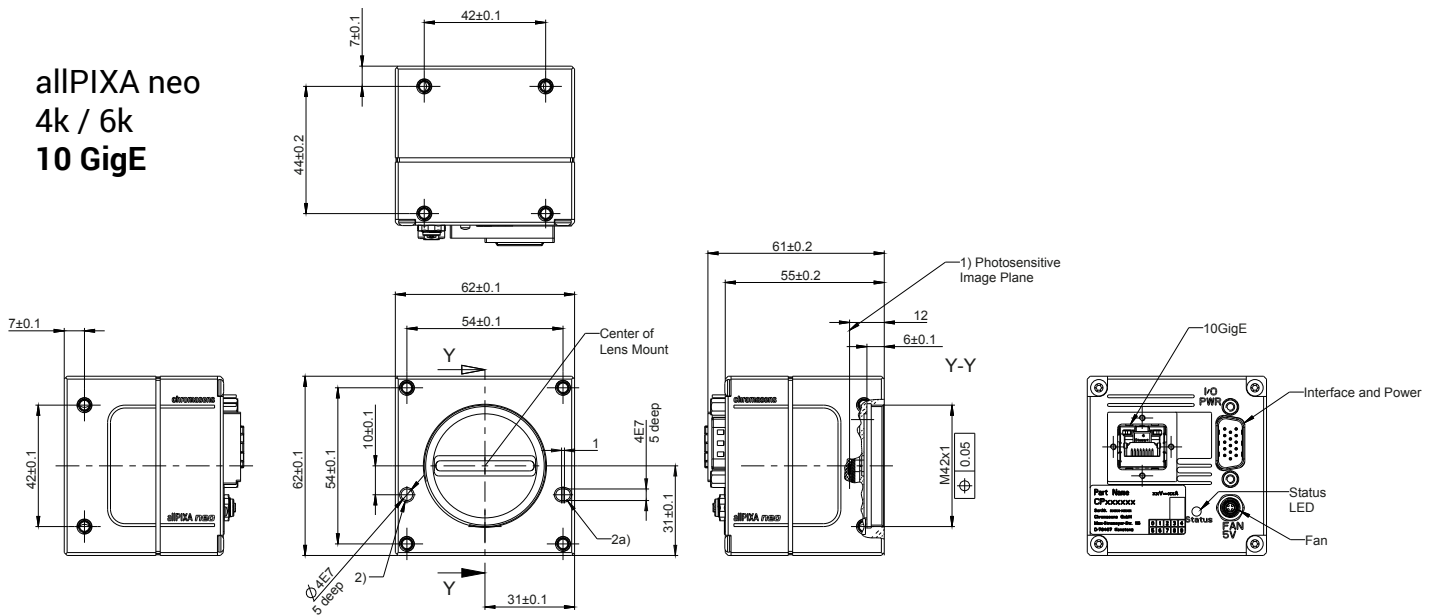

### allPIXA neo 4k / 6k CoaXPress

